

# covering 2000<sup>®</sup>

10/9/2007

BEKLEDINGSPROFIELEN  
PROFILES DE REVETEMENT  
BEKLEIDUNGSPROFILE  
COVERING PROFILES

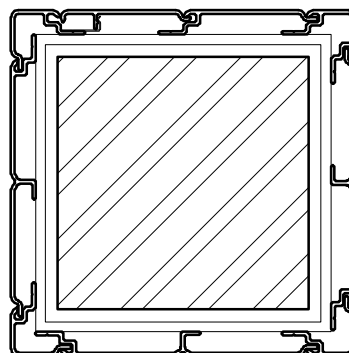

<b>PAa</b>	PROFIELEN _____ P. 7 PROFILS PROFILE PROFILES
<b>PAb</b>	TOEBEHOREN _____ P. 13 ACCESSOIRES ZUBEHORTEILE ACCESSORIES
<b>PAc</b>	DOORSNEDEN _____ P. 15 COUPES SCHNITT SECTIONS

## AFKORTINGEN / ABBREVIATIONS / ABKURZUNGEN / ABBREVIATIONS

BR = BRUT - BRUT - ROH - BRUT

AN = GEANODISEERD - ANODISE - ELOXIERT - ANODISED

AN (■) = GELAKT - LAQUE - LACKIERT - LACQUERED -- RAL9006M

KL = STANDAARDKLEUREN - COULEURS STANDARDS - BASIS FARBEN - BASIC COLORS

GS = SPECIAAL GEMOFFELD - LAQUE SPECIAL - SPECIALFARBE - SPECIAL COLOR

Z = ZWART - NOIR - SCHWARZ - BLACK

W = WIT - BLANC - WEISS - WHITE

De tekeningen die voorgesteld zijn op schaal 1:1, kunnen kleine maatafwijkingen vertonen, te wijten aan de reproductietechniek van deze catalogoog.









Les dessins représentés à l'échelle 1 peuvent avoir de légères variations dimensionnelles dues aux techniques de reproduction de ce catalogue.

Die Zeichnungen im Maßstab 1:1 können aus technischen Reproduktionsgründen leichte Messungsschwankungen darstellen.

The drawings represented on a scale 1 basis may have light dimensional variations due to the reproduction of the manual.



**BEGINSTUKKEN** \_\_\_\_\_ P. 7DEPARTS  
BEGINNSTUCKEN  
OPENING PIECES**EINDSTUKKEN** \_\_\_\_\_ P. 8PIECES FINALES  
ENDSTUCKEN  
END PIECES**BUITENHOEKEN** \_\_\_\_\_ P. 9ANGLES EXTERIEURS  
AUSSENECKS  
OUTSIDE CORNERS**BINNENHOEKEN** \_\_\_\_\_ P. 10ANGLES INTERIEURS  
INNENECKS  
INSIDE CORNERS**BEKLEDINGSPROFIELEN** \_\_\_\_\_ P. 11PLANCHETS  
BEKLEIDUNGSPROFIELEN  
COVERPROFILES

DOORSNEDES \_\_\_\_\_ P. 15  
COUPES  
SCHNITTS  
SECTIONS

NUMMER NUMERO NUMBER NUMBER	AFBEELDING IMAGE BILD PICTURE	BLAD PAGE SEITE PAGE	OMTREK PERIM. UMRIB PERIM. mm	MECH. MEC. MEC. MEC. mm	lxx cm4	lyy cm4	LENGTE LONG. LANGE LENGTH	VERP. PER EMB. PAR PACK PR. PACK PR.	BR	AN	KL	GS	M1
PA001		7	103.1	32	-	-	6.5	6	X	X	X	X	
PA002		8	75.2	32	-	-	6.5	6	X	X	X	X	
PA005		9	135.8	47	-	-	6.5	6	X	X	X	X	
PA006		9	169.1	41	-	-	6.5	6	X	X	X	X	
PA007		10	175.2	41	-	-	6.5	6	X	X	X	X	
PA050		11	161.4	57	-	-	6.5	6	X	X	X	X	
PA051		11	129.1	59	-	-	6.5	6	X	X	X	X	
PA100		11	297.3	109	-	-	6.5	4	X	X	X	X	
PA101		11	297.7	110	-	-	6.5	2	X	X	X	X	

BR = BRUT - BRUT - ROH - BRUT  
 AN = ANODISATIE - ANODISE - ELOXIERT - ANODISED  
 KL = STANDAARDKLEUREN - COULEUR STANDARD - BASIS FARBEN - BASIC COLORS  
 GS = GEMOFFELD SPECIAAL - LAQUE SPECIAL - SPECIALFARBE - SPECIAL COLOR  
 M1 = BICOLOR - BICOLOR - BICOLOR - BICOLOR

A = BUITEN - EXTERIEUR - AUSSEN - OUTSIDE  
 B = BINNEN - INTERIEUR - INNEN - INSIDE

NUMMER NUMERO NUMBER	AFBEELDING IMAGE BILD PICTURE	BLAD PAGE SEITE PAGE	OMTREK PERIM. UMRIB PERIM. mm	MECH. MEC. MECH. MEC. mm	lxx cm4	lyy cm4	LENGTE LONG. LANGE LENGTH	VERP. PER EMB. PAR PACK PR. PACK PR.	BR	AN	KL	GS	M1
PA150		11	430.3	163	-	-	6.5	2	X	X	X	X	
PA151		11	430.1	160	-	-	6.5	2	X	X	X	X	

BR = BRUT - BRUT - ROH - BRUT  
AN = ANODISATIE - ANODISE - ELOXIERT - ANODISED  
KL = STANDAARDKLEUREN - COULEUR STANDARD - BASIS FARBEN - BASIC COLORS  
GS = GEMOFFELD SPECIAAL - LAQUE SPECIAL - SPECIALFARBE - SPECIAL COLOR  
M1 = BICOLOR - BICOLOR - BICOLOR - BICOLOR

BEGINSTUK 20MM  
DEPART 20MM  
BEGINNSTUCK 20MM  
OPENING PIECE 20MM

PROFIELEN - PROFILS- PROFILE - PROFILES

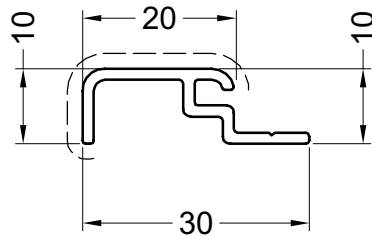

PA001

pag-a3

-----  
Primaire zichtbare zijde  
Face visible primaire  
Primär sichtbare Seite  
Primary visible side

-----  
Secundaire zichtbare zijde  
Face visible secondaire  
Secondär sichtbare Seite  
Secondary visible side

27/4/06

EINDSTUK 20MM  
PIECE FINALE 20MM  
ENDSTUCK 20MM  
END PIECE 20MM

PROFIELEN - PROFILS- PROFILE - PROFILES

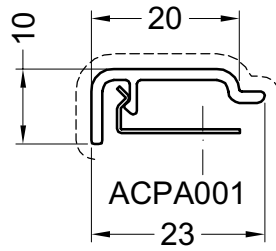

PA002



BUITENHOEKEN  
ANGLES EXTERIEURS  
AUSSENECKS  
OUTSIDE CORNERS

PROFIELEN - PROFILS- PROFILE - PROFILES

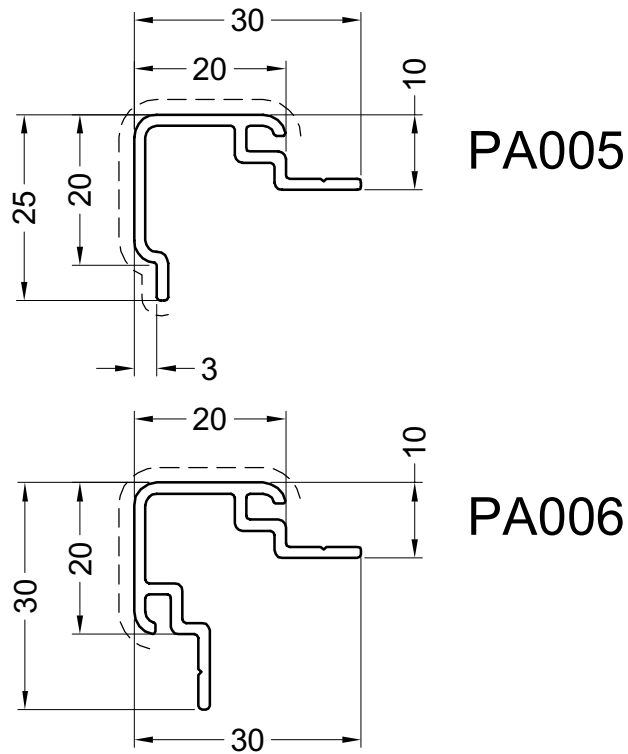

pag-a7

Primaire zichtbare zijde  
Face visible primaire  
Primär sichtbare Seite  
Primary visible side

Secundaire zichtbare zijde  
Face visible secondaire  
Secondär sichtbare Seite  
Secondary visible side

BINNENHOEKEN  
ANGLES INTERIEURS  
INNENECKS  
INSIDE CORNERS

PROFIELEN - PROFILS- PROFILE - PROFILES

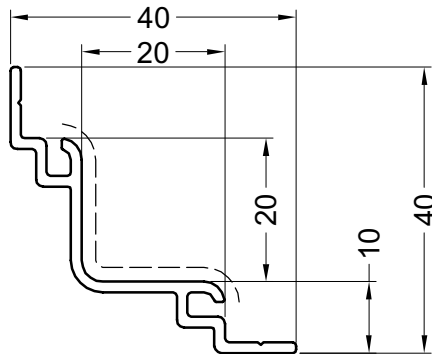

PA007

BEKLEDINGSPROFIELEN  
PLANCHETS  
BEKLEIDUNGSPROFIELEN  
COVERPROFILES

PROFIELEN - PROFILS- PROFILE - PROFILES

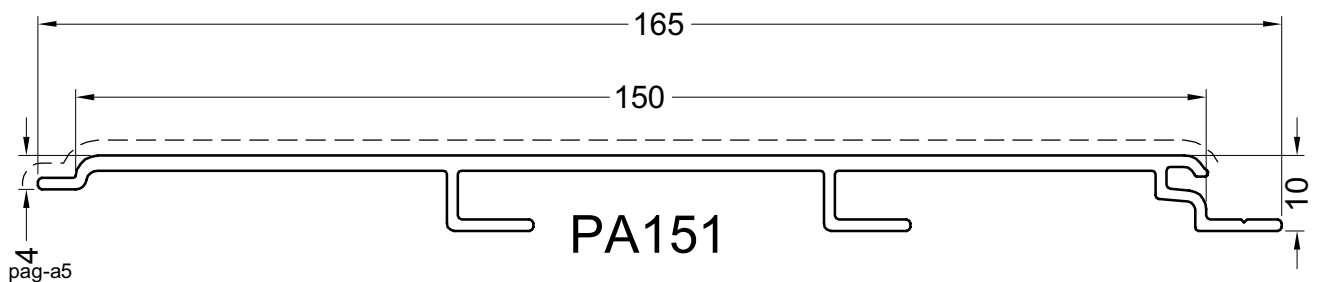
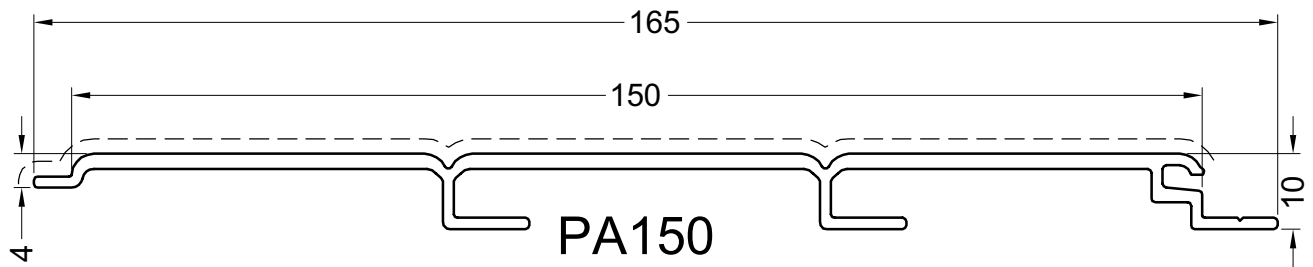
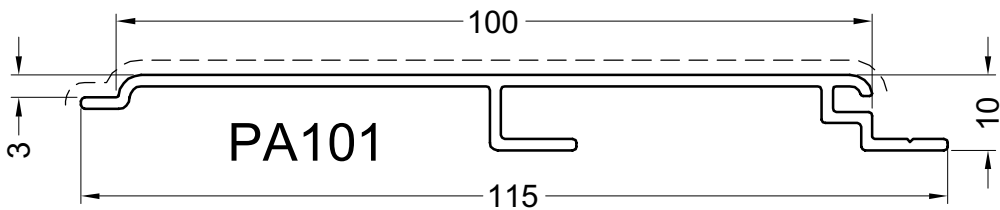
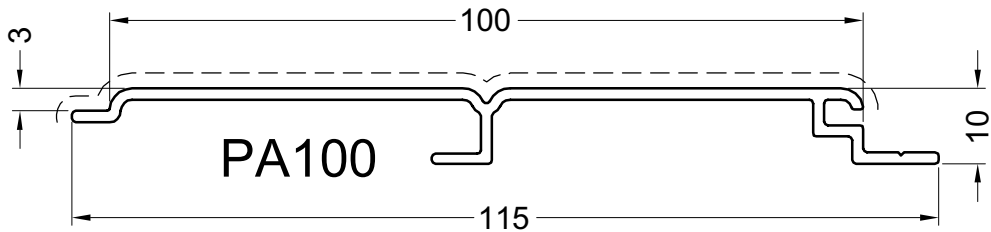
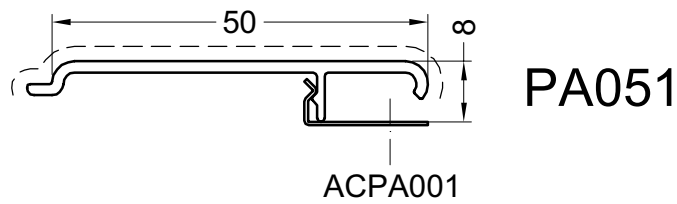
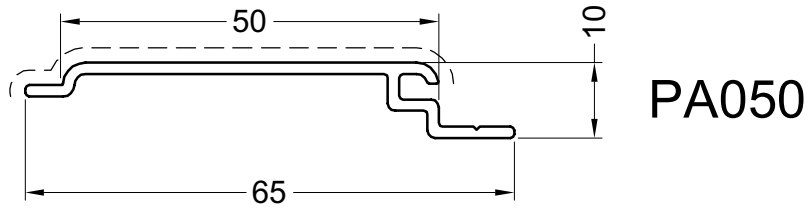

Primaire zichtbare zijde  
Face visible primaire  
Primär sichtbare Seite  
Primary visible side

Secundaire zichtbare zijde  
Face visible secondaire  
Secondär sichtbare Seite  
Secondary visible side



	Verp. per Emb. par Pack pr.	Einheid Unité Einheit Unit	Toepassing Application Anwendung Application	Kleur Couleur Farbe Color												
	1	Stuk Pièce Stück Piece	PA002 PA051	<table border="1"> <tr> <td>BR</td> <td>X</td> </tr> <tr> <td>AN</td> <td></td> </tr> <tr> <td>KL</td> <td></td> </tr> <tr> <td>GS</td> <td></td> </tr> <tr> <td>Z</td> <td></td> </tr> <tr> <td>W</td> <td></td> </tr> </table>	BR	X	AN		KL		GS		Z		W	
BR	X															
AN																
KL																
GS																
Z																
W																
<p><b>ACPA001</b></p> <p>-Clips -Clips -Clips -Clips</p>																

BR = BRUT - BRUT - ROH - BRUT  
 AN (X) = ANODISATIE - ANODISE - ELOXIERT - ANODISED  
 AN (■) = GELAKT - LAQUE - LACKIERT - LACQUERED -- RAL9006M  
 KL = STANDAARDKLEUREN - COULEUR STANDARD - BASIS FARBEN - BASIC COLORS  
 GS = GEMOFFELD SPECIAAL - LAQUE SPECIAL - SPECIALFARBE - SPECIAL COLOR  
 Z = ZWART - NOIR - SCHWARZ - BLACK  
 W = WIT - BLANC - WEISS - WHITE



GEREEDSCHAP - OUTILLAGE  
WERKZEUG - TOOL

BEVESTIGING - FIXATION  
BEFESTIGUNG - FIXATION





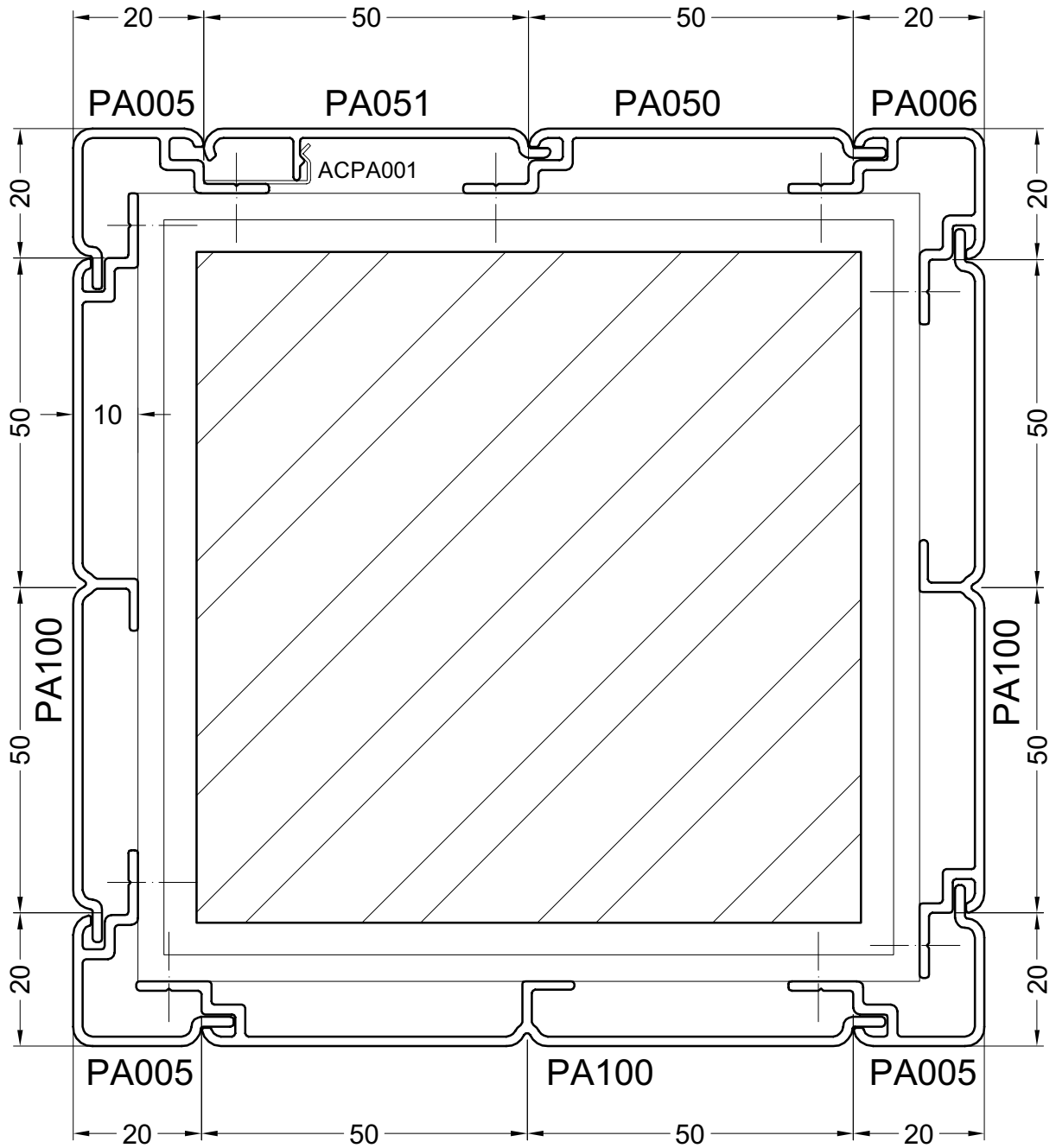

DOORSNEDE - COUPE - SCHNITT - SECTION

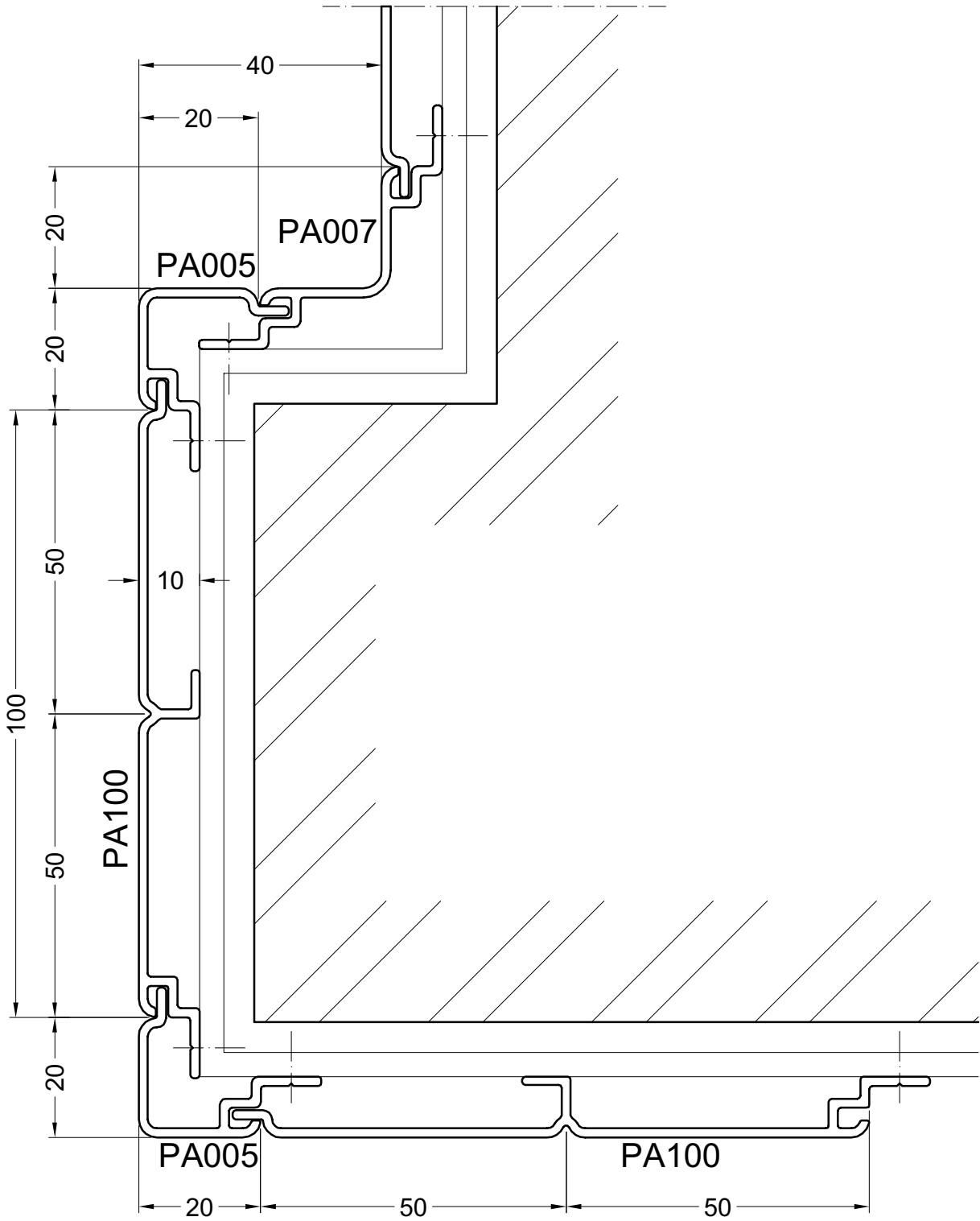

pag-c2



